

Phase leg MOSFET Power Module

$V_{DSS} = 500V$
 $R_{DSon} = 17m\Omega \text{ typ @ } T_j = 25^\circ C$
 $I_D = 180A \text{ @ } T_c = 25^\circ C$

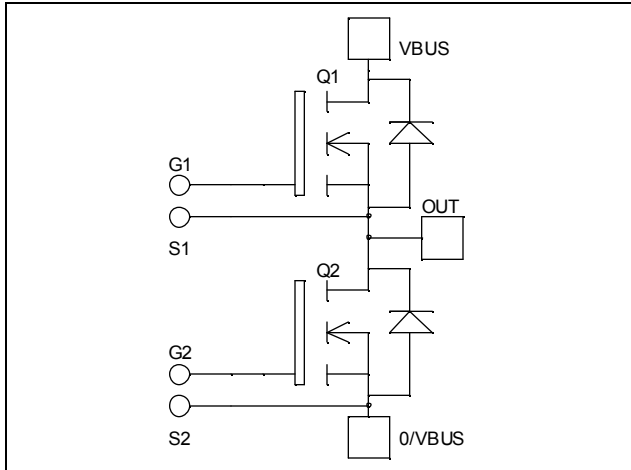

Application

- Welding converters
- Switched Mode Power Supplies
- Uninterruptible Power Supplies
- Motor control

Features

- Power MOS 7[®] FREDFETs
 - Low R_{DSon}
 - Low input and Miller capacitance
 - Low gate charge
 - Fast intrinsic reverse diode
 - Avalanche energy rated
 - Very rugged
- Kelvin source for easy drive
- Very low stray inductance
 - Symmetrical design
 - M5 power connectors
- High level of integration

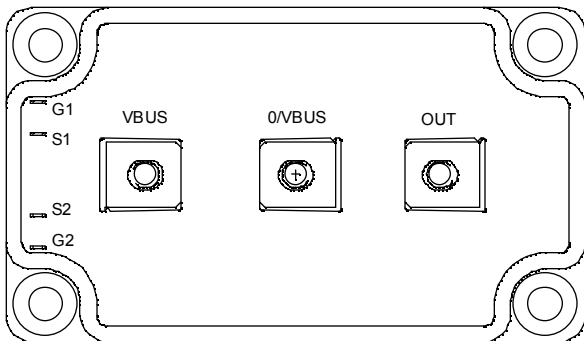

Benefits

- Outstanding performance at high frequency operation
- Direct mounting to heatsink (isolated package)
- Low junction to case thermal resistance
- Low profile
- RoHS Compliant

Absolute maximum ratings

Symbol	Parameter	Max ratings	Unit
V_{DSS}	Drain - Source Breakdown Voltage	500	V
I_D	Continuous Drain Current	$T_c = 25^\circ C$	180
		$T_c = 80^\circ C$	135
I_{DM}	Pulsed Drain current	720	A
V_{GS}	Gate - Source Voltage	± 30	V
R_{DSon}	Drain - Source ON Resistance	20	m Ω
P_D	Maximum Power Dissipation	$T_c = 25^\circ C$	1250
I_{AR}	Avalanche current (repetitive and non repetitive)	51	A
E_{AR}	Repetitive Avalanche Energy	50	mJ
E_{AS}	Single Pulse Avalanche Energy	3000	

CAUTION: These Devices are sensitive to Electrostatic Discharge. Proper Handling Procedures Should Be Followed. See application note APT0502 on www.microsemi.com

All ratings @ $T_j = 25^\circ\text{C}$ unless otherwise specified

Electrical Characteristics

Symbol	Characteristic	Test Conditions	Min	Typ	Max	Unit
I_{DSS}	Zero Gate Voltage Drain Current	$V_{GS} = 0\text{V}, V_{DS} = 500\text{V}$			400	μA
		$V_{GS} = 0\text{V}, V_{DS} = 400\text{V}$			2000	
$R_{DS(on)}$	Drain – Source on Resistance	$V_{GS} = 10\text{V}, I_D = 90\text{A}$		17	20	$\text{m}\Omega$
$V_{GS(th)}$	Gate Threshold Voltage	$V_{GS} = V_{DS}, I_D = 10\text{mA}$	3		5	V
I_{GSS}	Gate – Source Leakage Current	$V_{GS} = \pm 30\text{V}, V_{DS} = 0\text{V}$			± 200	nA

Dynamic Characteristics

Symbol	Characteristic	Test Conditions	Min	Typ	Max	Unit
C_{iss}	Input Capacitance	$V_{GS} = 0\text{V}$		28		nF
C_{oss}	Output Capacitance	$V_{DS} = 25\text{V}$		5.6		
C_{rss}	Reverse Transfer Capacitance	$f = 1\text{MHz}$		0.36		
Q_g	Total gate Charge	$V_{GS} = 10\text{V}$		560		nC
Q_{gs}	Gate – Source Charge	$V_{Bus} = 250\text{V}$		160		
Q_{gd}	Gate – Drain Charge	$I_D = 180\text{A}$		280		
$T_{d(on)}$	Turn-on Delay Time	Inductive switching @ 125°C $V_{GS} = 15\text{V}$ $V_{Bus} = 333\text{V}$ $I_D = 180\text{A}$ $R_G = 0.5\Omega$		21		ns
T_r	Rise Time			38		
$T_{d(off)}$	Turn-off Delay Time			75		
T_f	Fall Time			93		
E_{on}	Turn-on Switching Energy	Inductive switching @ 25°C $V_{GS} = 15\text{V}, V_{Bus} = 333\text{V}$ $I_D = 180\text{A}, R_G = 0.5\Omega$		4140		μJ
E_{off}	Turn-off Switching Energy			3380		
E_{on}	Turn-on Switching Energy	Inductive switching @ 125°C $V_{GS} = 15\text{V}, V_{Bus} = 333\text{V}$ $I_D = 180\text{A}, R_G = 0.5\Omega$		6224		μJ
E_{off}	Turn-off Switching Energy			4052		

Source - Drain diode ratings and characteristics

Symbol	Characteristic	Test Conditions	Min	Typ	Max	Unit	
I_S	Continuous Source current (Body diode)	$T_c = 25^\circ\text{C}$			180	A	
		$T_c = 80^\circ\text{C}$			135		
V_{SD}	Diode Forward Voltage	$V_{GS} = 0\text{V}, I_S = -180\text{A}$			1.3	V	
dv/dt	Peak Diode Recovery ①				15	V/ns	
t_{rr}	Reverse Recovery Time	$I_S = -180\text{A}$ $V_R = 333\text{V}$ $di/dt = 400\text{A}/\mu\text{s}$	$T_j = 25^\circ\text{C}$			270	ns
			$T_j = 125^\circ\text{C}$			540	
Q_{rr}	Reverse Recovery Charge	$I_S = -180\text{A}$ $V_R = 333\text{V}$ $di/dt = 400\text{A}/\mu\text{s}$	$T_j = 25^\circ\text{C}$		10.4	μC	
			$T_j = 125^\circ\text{C}$		38.4		

 ① dv/dt numbers reflect the limitations of the circuit rather than the device itself.

$$I_S \leq -180\text{A} \quad di/dt \leq 700\text{A}/\mu\text{s} \quad V_R \leq V_{DSS} \quad T_j \leq 150^\circ\text{C}$$

Thermal and package characteristics
Symbol Characteristic

		<i>Min</i>	<i>Typ</i>	<i>Max</i>	<i>Unit</i>	
R_{thJC}	Junction to Case Thermal Resistance			0.1	°C/W	
V_{ISOL}	RMS Isolation Voltage, any terminal to case $t=1$ min, $I_{isol}<1$ mA, 50/60Hz	2500			V	
T_J	Operating junction temperature range	-40		150	°C	
T_{STG}	Storage Temperature Range	-40		125		
T_C	Operating Case Temperature	-40		100		
Torque	Mounting torque	To heatsink	M6	3	5	N.m
		For terminals	M5	2	3.5	
Wt	Package Weight			280	g	

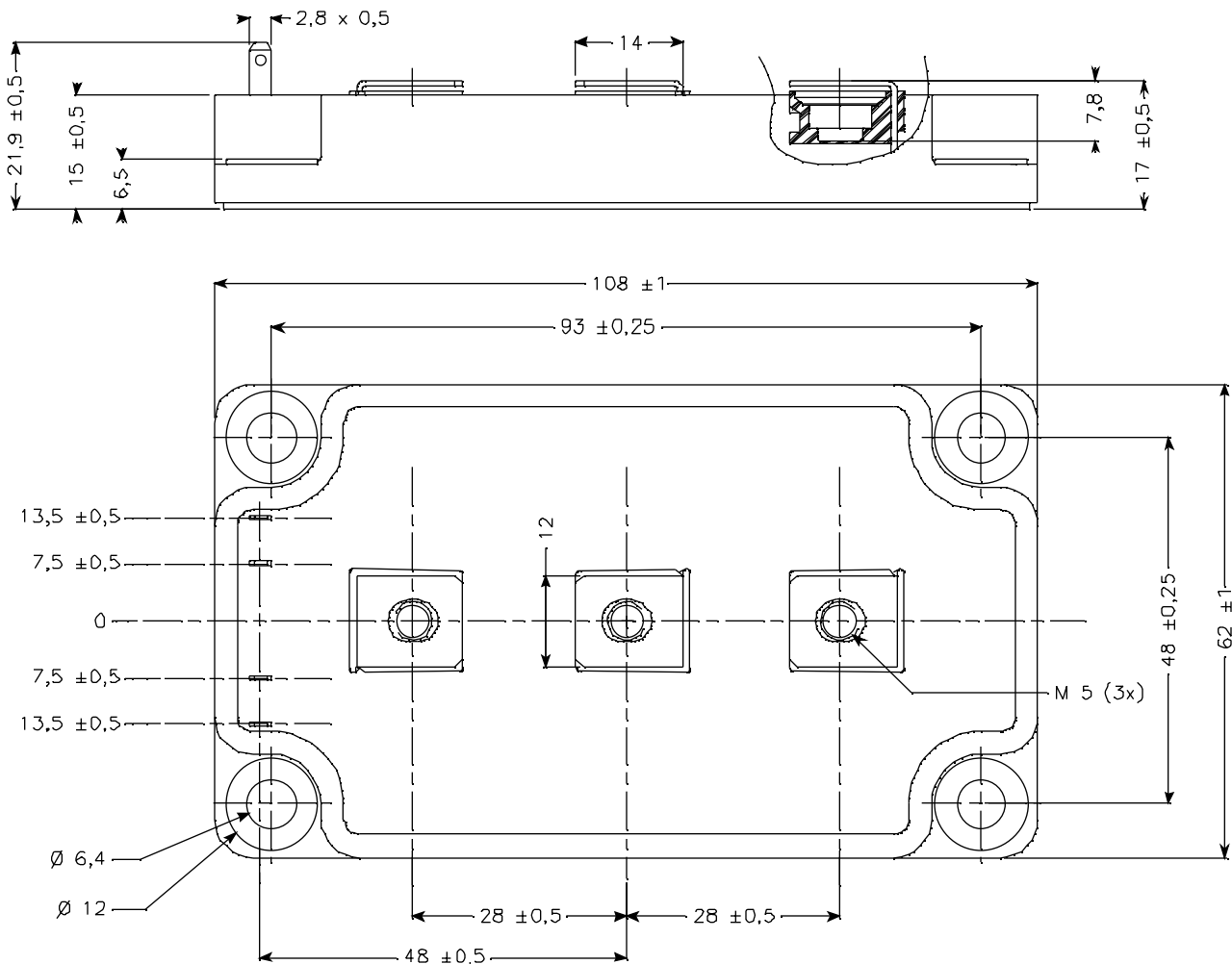
SP6 Package outline (dimensions in mm)

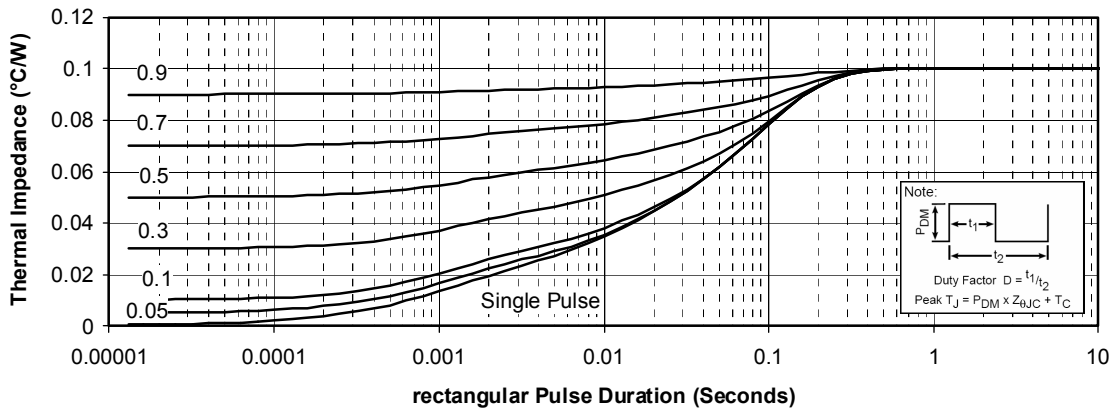
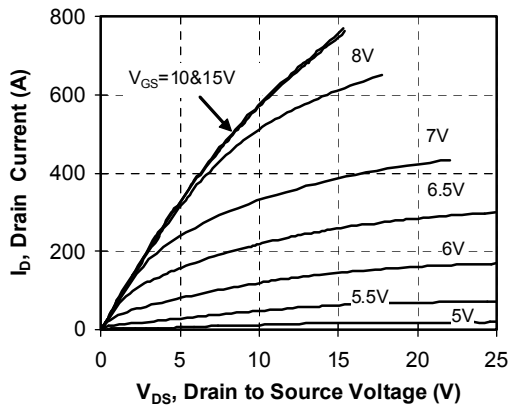
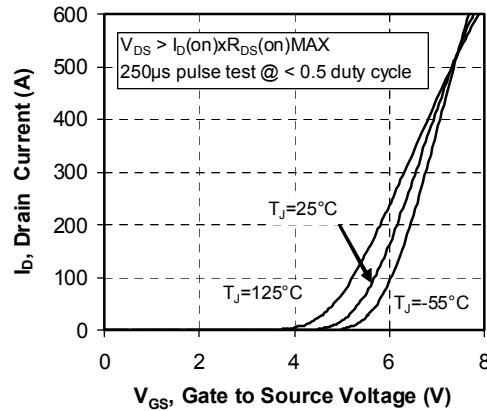
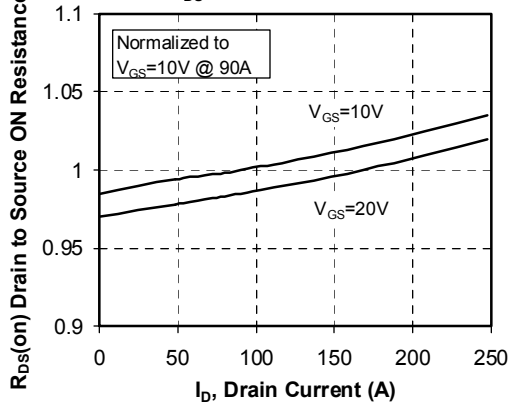
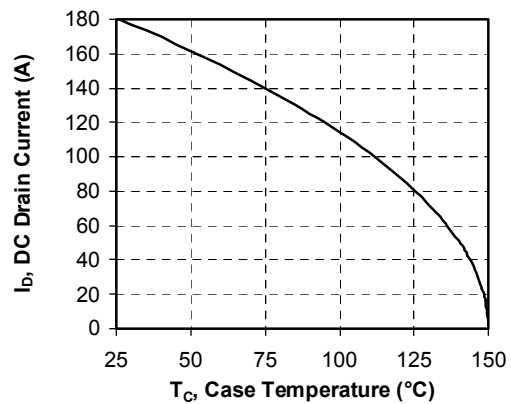
 See application note APT0601 - Mounting Instructions for SP6 Power Modules on www.microsemi.com

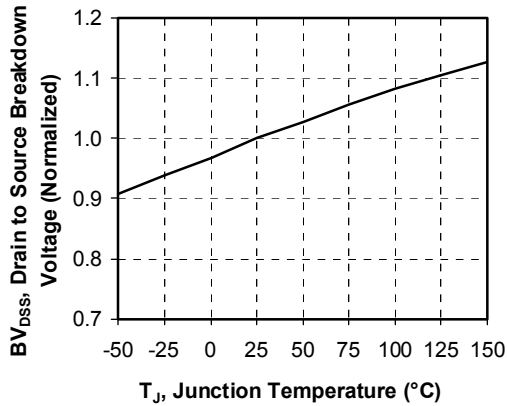
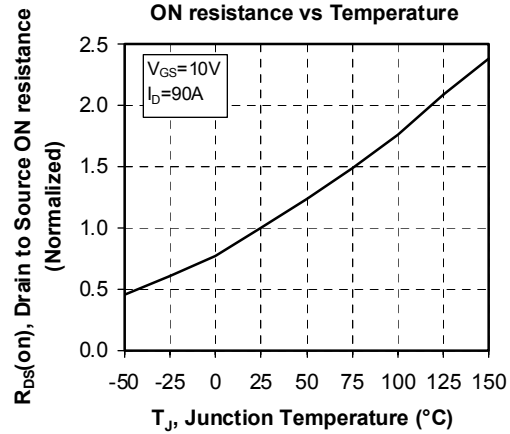
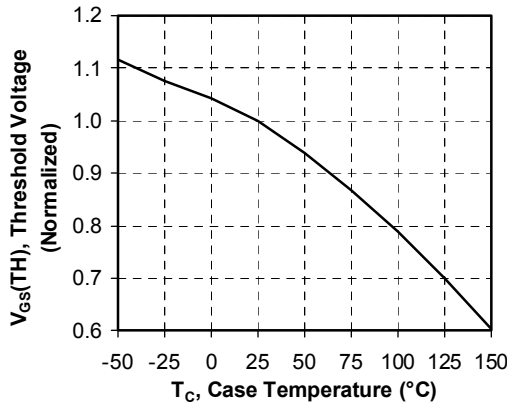
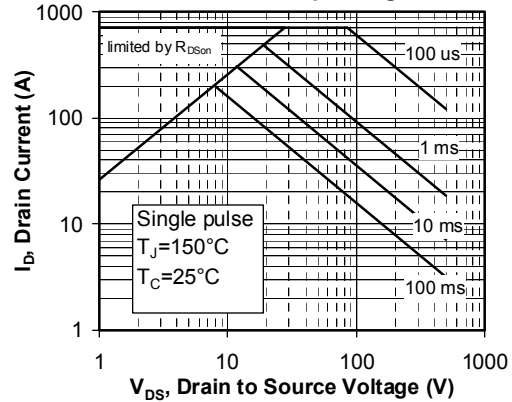
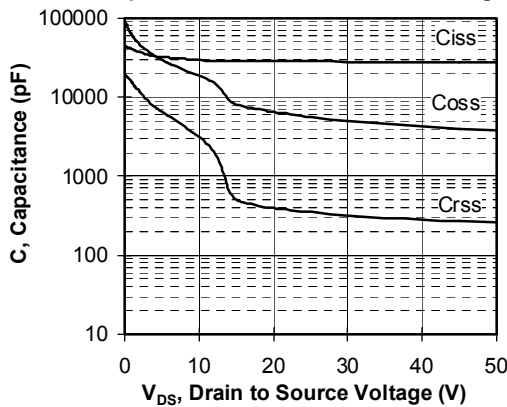
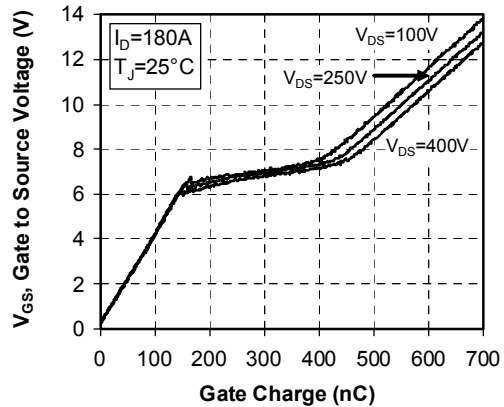
Typical Performance Curve
Maximum Effective Transient Thermal Impedance, Junction to Case vs Pulse Duration

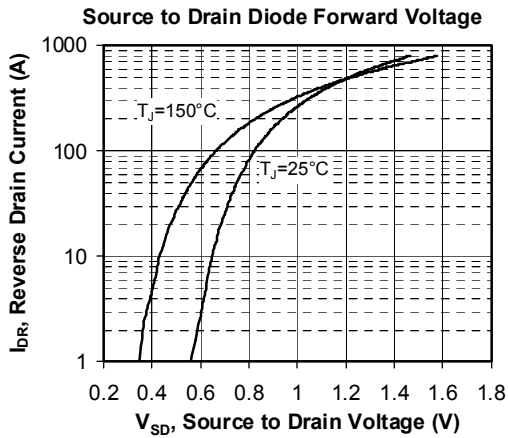
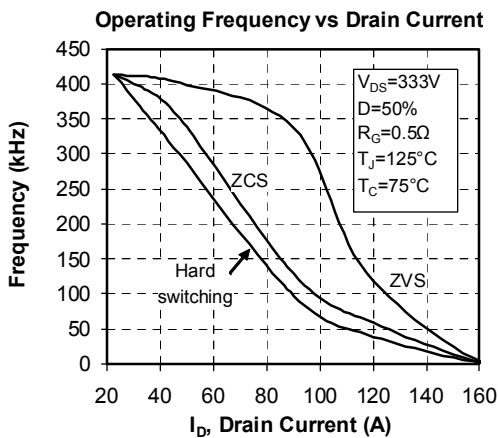
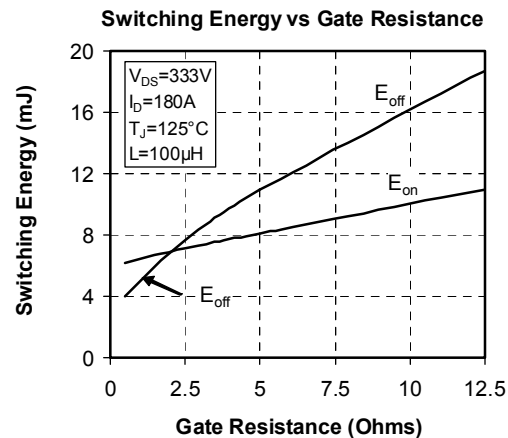
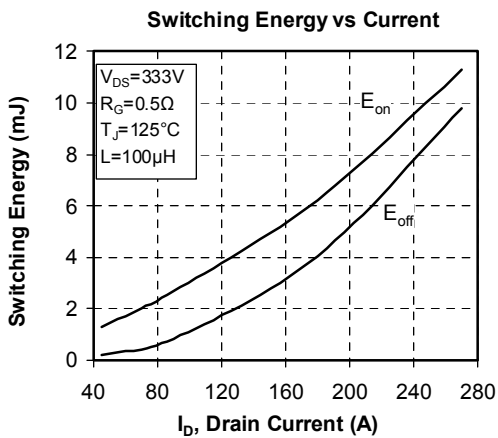
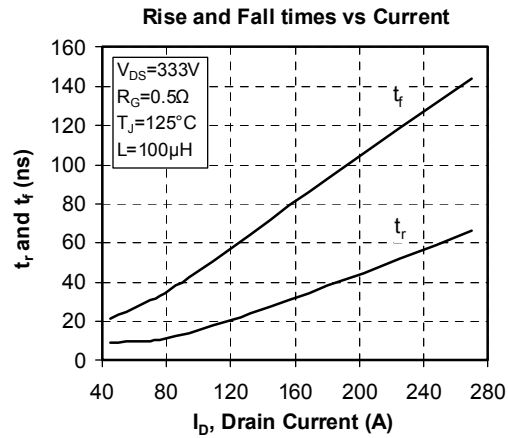
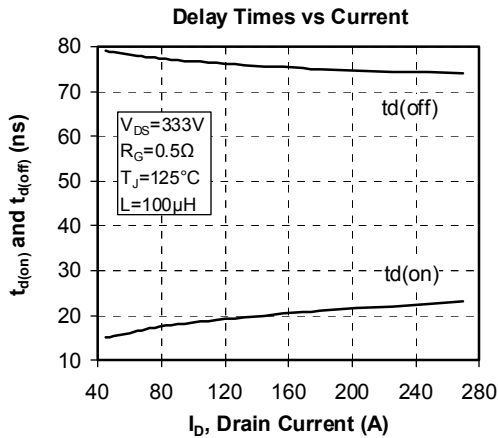
Low Voltage Output Characteristics

Transfer Characteristics

R_{DS(on)} vs Drain Current

DC Drain Current vs Case Temperature

Breakdown Voltage vs Temperature

ON resistance vs Temperature

Threshold Voltage vs Temperature

Maximum Safe Operating Area

Capacitance vs Drain to Source Voltage

Gate Charge vs Gate to Source Voltage



Microsemi reserves the right to change, without notice, the specifications and information contained herein

Microsemi's products are covered by one or more of U.S. patents 4,895,810 5,045,903 5,089,434 5,182,234 5,019,522 5,262,336 6,503,786 5,256,583 4,748,103 5,283,202 5,231,474 5,434,095 5,528,058 and foreign patents. U.S. and Foreign patents pending. All Rights Reserved.